



! WARNING!

Read and understand this manual and all instructions before operating this wheelbarrow!





Product Specifications

- Max. speed: 3.5km/h
- Max. load: 120kg
- Motor: Carbon brush motor 230W / 50 min⁻¹
- Brake: D180mm Adjustable disk brake
- Structure: Low carbon steel
- Surface coating: Powder coating
- Dimensions: Length 138cm, Width 80cm, Height 97cm
- Tire: 4.80/4.00-8(φ400mm)..4.10/3.50-4
- Battery: DC 24V, 10A Module
- Overload protection: Yes
- Charger: 230V/50Hz DC24V/1A
- Max. slope: 12 degrees
- Weight: 41.5Kg (Inc. battery)
- Volume: 116L or 6 cu.Ft

Operating Conditions

- Working temperature: between -10° and 40°
- Altitude: up to 2000m
- Relative humidity: between 30% and 95%

Warning Signs

	Be careful when using this barrow.
	Read this manual carefully before using this barrow.
	DO NOT use this barrow at a slope greater than 12 degrees.
	DO NOT load this barrow over 120kg.

Components List

Before assembling the SPB-500 Electric Wheelbarrow, check that you have all the following module and parts available:

1. Tray x 1
2. Tray rack x 1
3. Base module (front wheel, handle, brake, and speed controller) x 1
4. Rear wheel x 2
5. Battery x 1
6. Charger x 1
7. Fasteners pack x 1

Exploded View

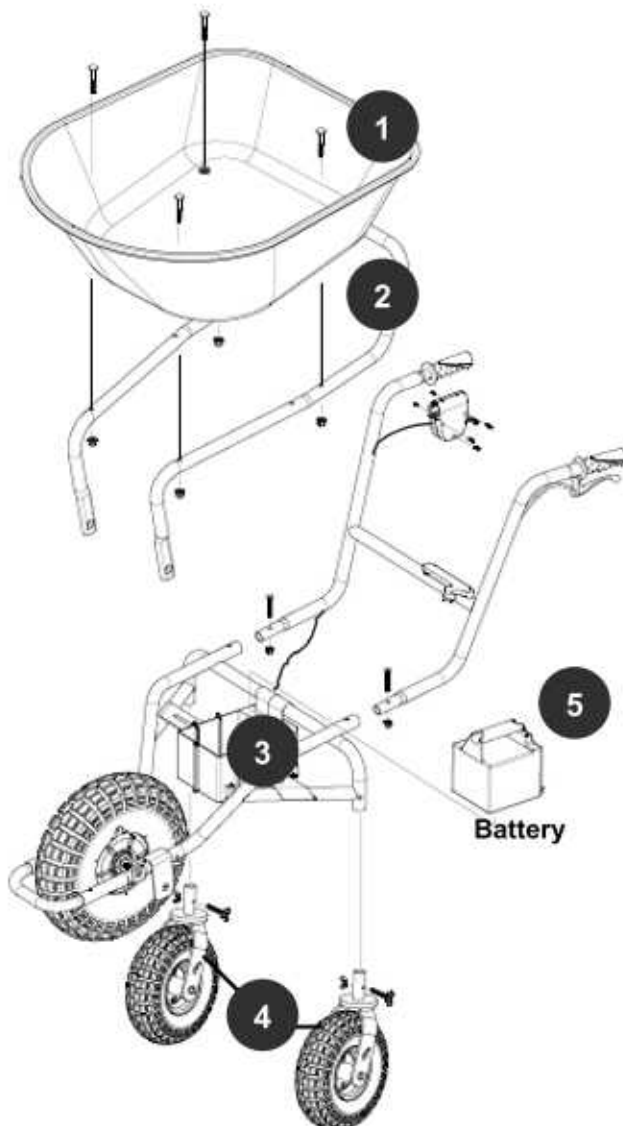

Fasteners pack

Assembling the SPB-500 Wheelbarrow

Please read and follow the following instructions carefully. This procedure will guide you through the correct steps to assemble your wheel barrow and ensure safe use.

Step 0: The first charge of the battery will take between 8 to 24 hours, we recommend that you start charging before assembling the wheelbarrow. Please refer to the section “Charging and Caring for the Battery” on page 9 for instructions.

Step 1: Rest the base module with handle on the ground (**Figure 1**). Get 2 sets of rear wheels and 2 sets of wing bolts and nuts ready (**Figure 2**).

Wing bolt: M8*P1.25*45mm x 2

Wing nut: M8*P1.25mm x 2

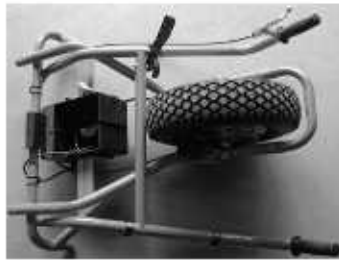

Figure 1



Figure 2

Step 2: Insert one of the wheels into one side of the base unit tube. Align the holes (**Figure 3**) so that the wing bolt can be put through (**Figure 4**). Fasten the bolt and nut and make sure they are tight enough (**Figure 5**). Your half-assembled wheelbarrow should now look like **Figure 6**.



Figure 3



Figure 4



Figure 5



Figure 6

Step 3: Now turn the handle into the correct orientation. Insert the tubes on both sides. Use hex bolts and nuts (**Figure 7**) for fastening (**Figure 8**). Your wheelbarrow should now look like **Figure 9**. Wrench size.

Bolt: M8*P1.25*45mm x 2

Nut: M8*P1.25*t11mm x 2



Figure 7



Figure 8



Figure 9

Step 4: Take out the speed controller that has been pre-connected to the front wheel from the battery container. You may find that the brake has been installed on one side of the handles. Fasten the speed controller to the other handle (**Figure 10**).

NOTE: Ensure the speed controller unit is pushed against the handle grip (**Figure 10.1**). Any gap between the speed controller and grip may lead to a reduction in speed control, slower operating speeds or failure to operate.



Figure 10



Figure 10.1

Step 5: Fix the dangling wire of the speed controller on the handle tube with the tightening bend that has been pre-assembled to the tube.



Figure 11

Step 6: At this point, you should make sure the wires are correctly tightened at the 5 locations circled in **Figure 12**. It is also very important to make sure the wires are going from outside of the tube frame to avoid any possible damage of wires by the tray.

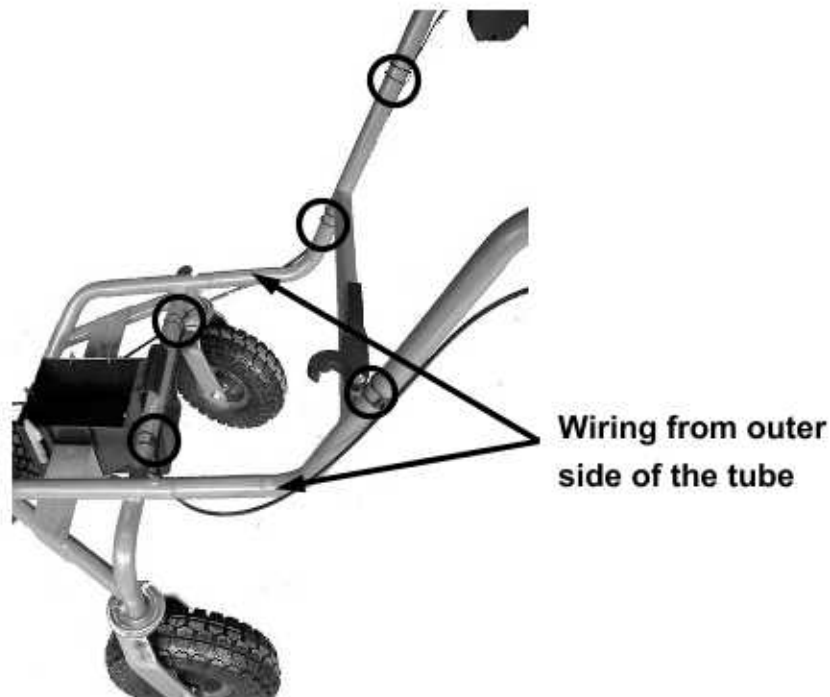

Figure 12

Step 7: Get the tray rack and 2 sets of hex nuts, bolts, and washers ready (Figure 13 & 14). Insert the bolt and washer into the rack like **Figure 15-1**. Put on the other washer and nut like **Figure 15-2**. Make sure they are fastened tightly enough (**Figure 15-3**).

Bolt: M16*P2.0*45mm x 2 Inner washer: D21.9*d16*15mm x 2
Nut: M16*P2.0*t12.7mm x 2 Spring washer: D26*d16.5*t3.0mm x 2



Figure 13



Figure 14



Figure 15-1



Figure 15-2



Figure 15-3

Step 8: Obtain the tray and 4 sets of bolts and nuts (**Figure 16-1**), fasten it to the tray rack like it is shown in **Figure 16-2**.

Bolt: M8*P1.25*L45mm x 4

Nut: M8*P1.25*t11mm x 4



Figure 16-1



Figure 16-2

IMPORTANT: At this point, it is very important to make sure that the wires run down the tube **DO NOT interfere** with the tray or get between the tubes. If you do, please redo the wiring as shown in **Figure 17-1** and **17-2**.



Figure 17-2

Congratulations! Now your SPB-500 has been completely assembled!



Installing the Battery

Step 1: Depress the brake stopper on the hand brake to stop the wheelbarrow without having to hold it (**Figure 18**). Stand at the side and lift the tray up (**Figure 19**). Please make sure there is no person in front of the barrow.



Figure 18



Figure 19

Step 2: Install the battery into the battery holder (**Figure 20-1**). Remember to secure it by rotating the stopper (**Figure 20-2**).



Step 3: Simply lift the brake slightly to de-activate the brake stopper (**Figure 21**).



Figure 21

Operating the Wheelbarrow

Starting the Wheelbarrow

Switch on the power by pressing the power button. A red LED light lights up and indicates that you are ready to go (**Figure 22**). Activate the speed control by lifting the bar (**Figure 23**). The speed control is a variable type, which means the higher you lift the bar, the faster it will travel. Remember to switch off the power after each use. An explanation of label on the switch is explained in **Figure 24**.



Figure 22



Figure 23



Figure 24

Stopping the Wheelbarrow

Simply lift the brake handle to brake the wheelbarrow (**Figure 21**). Please refer to the “Install the Battery” section on how to stop the wheelbarrow using the stopper when you are on a slope or any other situations where you need to stop the wheelbarrow and be away.

Lifting the tray

Please refer to the “Install the Battery” section on how to lift the tray correctly when installing the battery or unloading the tray.

Securing the tray

Use the hook pre-installed on the handle to secure the tray during transportation, loaded or unloaded (**Figure 25**). This prevents the tray lifting due to poor road conditions.



Figure 25

WARNING!

- Wear shoes with non-slip treads when using the wheelbarrow. If you have safety shoes, wear them. Do not use the wheelbarrow while barefoot or wearing open sandals.
- When the wheelbarrow is left unattended, apply the brake stopper as shown in *Figure 18* to make sure the barrow stays in place.
- When the motor is overloaded, the current will be cut off and you will hear a buzzer. When this happens, wait for 5 seconds and the circuit will go back to normal.
- This product is intended for household use and is not intended for commercial or industrial uses.
- Please follow this manual exactly to avoid any misuse.

Charging and Caring for the Battery

The SPB-500 comes with a sealed, lead acid battery installed. The battery is 24 volts and rated at 10 amp-hours. The battery is completely maintenance free.

You should charge the battery before first use and after every use. The battery should also be charged out of the wheelbarrow to ensure safety.

First Charge

The battery has been charged at the factory; however you still need to recharge it fully before using the wheelbarrow. This normally takes 8 to 24 hours.

The charging port is located on the top of the battery next to the battery LED.

Recharging after each use

The battery should always be FULLY recharged immediately after each use. This is essential in extending the useful life of the battery.

Storage

When storing the battery for a long period of time, you are also recommended to leave it on charge. The charger will maintain a trickle charge to keep the battery ready for use. The storage temperature should be between 1° and 40°.

Instructions for Auto-Switching Charger

Charging procedure:

1. Connect the charger to battery
2. Plug in the charger to power source.
3. The charger now starts charging. The charger LED is RED during the charging stage.
4. When the charger LED turns GREEN, charging is completed. The charger can be left plugged in to maintain charge.

WARNING!

There is also an RED LED on the BATTERY. This RED LED only indicates that the battery is receiving power from the charger during charging. **It is NOT used to indicate when charging is completed and IT WILL NOT TURN GREEN.** If the LED does not light up, **DO NOT charge the battery further.** Call our customer service immediately.

Maintaining the Wheelbarrow

WARNING!

Battery **MUST BE REMOVED** before any maintenance can be carried out!

Lubricating the wheels

We recommend you to lubricate the wheels every 100 hours of use. This is to ensure smooth operation of the Wheelbarrow. Locate the grease nipples on the wheel, use a grease gun to inject grease into the wheel bearing (**Figure 27**). Any good quality Multi-purpose grease will suffice.



Figure 27

Adjusting the worn brake pad

Brake gap has to be adjusted when the brake force is weakened. Loosen B (internal hex screw) and turn E (adjustment screw) by turning in clockwise direction. Leave a gap of approximately 0.2mm between the disc and the brake pads. Tighten B after completing the adjustment.

The brake pads must be changed when the wear is visible. Loosen B and exit E (adjustment screw) in an anti-clockwise direction. Replace C (inner pad) first and D (outer pad second).

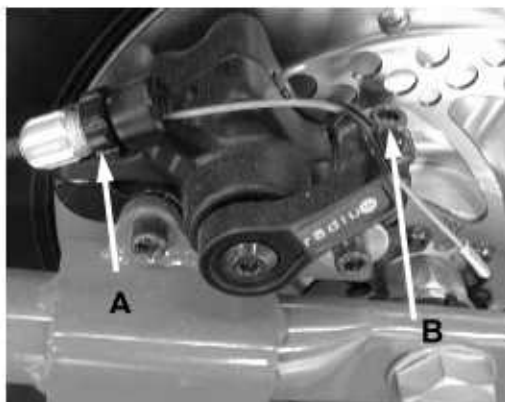

Figure 28

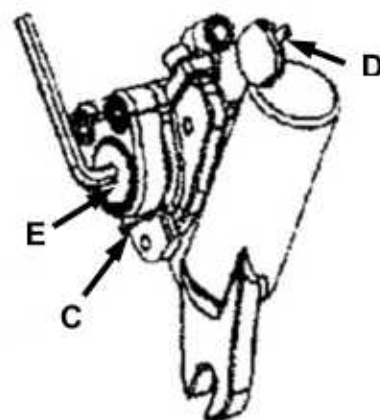

Figure 29

2-Year Limited Warranty

SPB-500 has a two (2) year warranty from the date of purchase. This also covers wearing parts against defects in materials or workmanship when put to domestic use.

The battery has a one (1) year limited warranty only.

Wearing parts include:

1. Tire/tube
2. Cables
3. Battery
4. Fuse
5. Break pad

Sherpa SPB-500 Wheelbarrow

is in compliance with the specification of the machine directive and subsequent modifications,

98/37/EC

Sherpa Tools
Magic House
Station Road
North Hykeham
Lincoln
LN6 9AL
TEL: 01522 283 020
www.sherpatools.co.uk